

---

# Ribberør LIF

## GoGetNo: 6963

---

Drawing Specification of Ribberør LIF

- ❖ Family with single view of 3d with Variation Detail
- ❖ Mechanical Equipment family
- ❖ 8 Family types :
  1. K101-164-12
  2. K33-73-08
  3. K33-83-10
  4. K42-92-10
  5. K48-98-10
  6. K60-110-10
  7. K60-123-12
  8. K76-139-12

---

### I. Family Variation

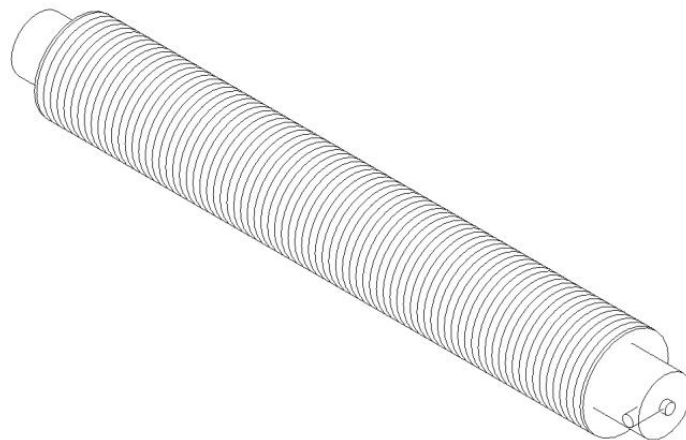

**Figure 01**  
Family Perspectives

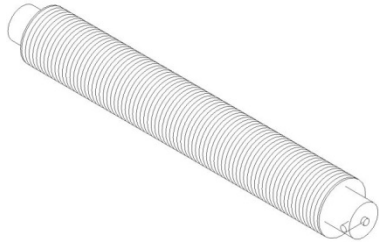

K101-164-12

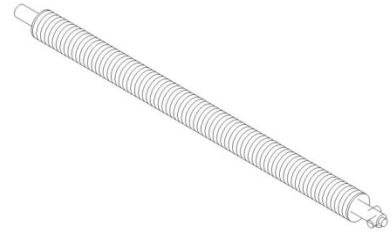

K33-73-08

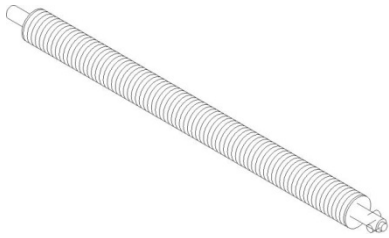

K33-83-10

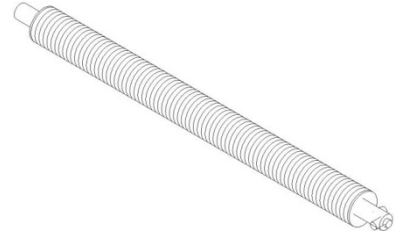

K42-92-10

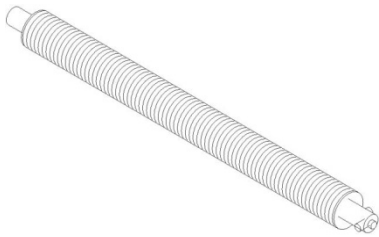

K48-98-10

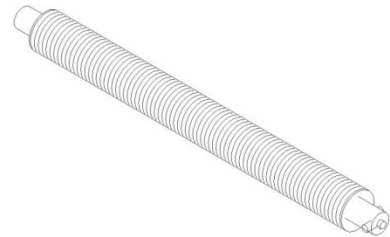

K60-110-10

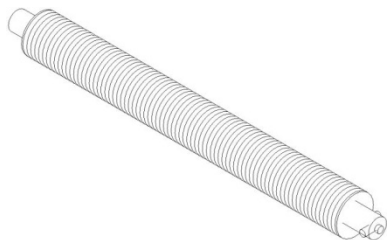

K60-123-12

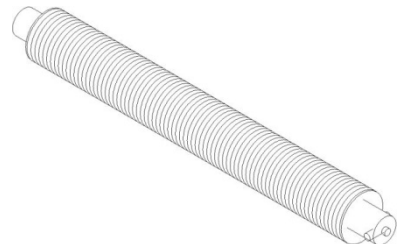

K76-139-12

**Figure 02**  
Variation of the family elevation

## II. Family Parameter and Code

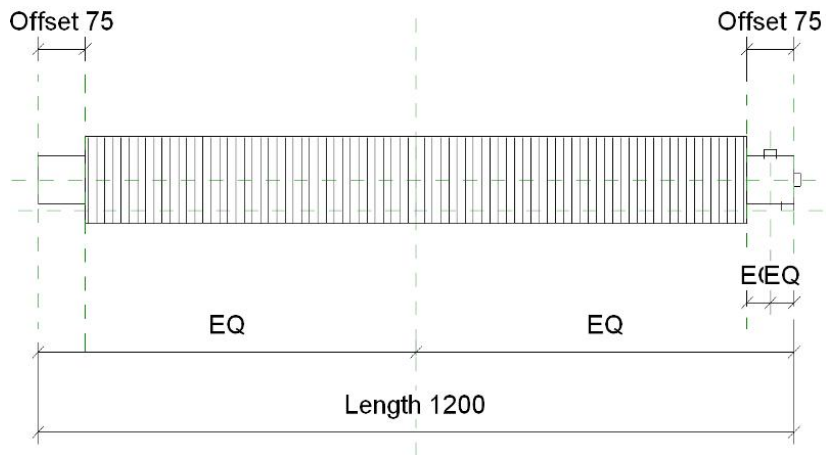

**Figure 03**  
Family Plan Reference

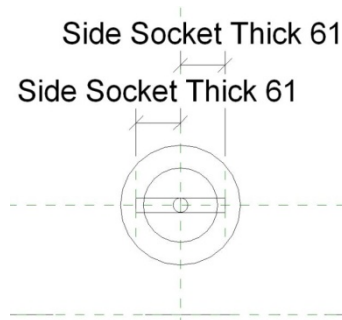

**Figure 04**  
Family Left Reference

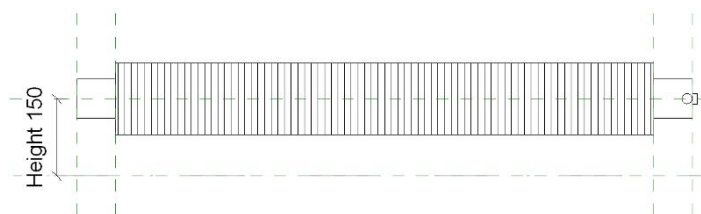

**Figure 05**  
Family Front Reference

**Family Types**

Name: K101-164-12

Parameter	Value	Formula
<b>Graphics</b>		
1501 Fins	<input checked="" type="checkbox"/>	=
<b>Materials and Finishes</b>		
2003 Tube	RAL 9016	=
2002 Socket	RAL 9016	=
2001 Fin Pitch	RAL 9016 F	=
<b>Electrical - Loads</b>		
Max #1 Pole Breakers	271	=
<b>Dimensions</b>		
1402 Length	1200.0	=
1401 Height	150.0	=
<b>Identity Data</b>		
1705 URL	http://www.meinertz.com	=
1703 Model	K101-164-12	=
1702 Manufacturer	Meinertz	=
1701 Keynote	K101-164-12	=
1706 GoGetNo	6963	= 6963
Type Comments		=
Description		=
Assembly Code		=
Cost		=
<b>Energy Analysis</b>		
1201 Thermal Performance	216.000000	= CTP * Length / 1000 mm
<b>Other</b>		
9805 Welded Thick	10.0	=
9807 Tube Radius	50.8	= Tube Diameter / 2
9804 Tube Diameter	101.6	=
9803 Socket Radius	10.0	=
9808 Side Socket Thick	60.8	= Tube Radius + Welded Thick
9802 Offset	75.0	=
9806 Fin Radius	82.0	= Fin Diameter / 2
9801 Fin Diameter	164.0	=
9809 CTP	180	= if(Fin Diameter = 73 mm, 88, if(Fin

Family Types: New..., Rename..., Delete

Parameters: Add..., Modify..., Remove

OK Cancel Apply Help

**Figure 06**  
Family Parameter Reference