Ribberør 3SE

GoGetNo: 6974

Drawing Specification of Ribberør 3SE

- ❖ Family with single view of 3d with Variation Detail
- ❖ Mechanical Equipment family
- ❖ 8 Family types :
 1. K33-73-08
 2. K33-83-10
 3. K42-92-10
 4. K48-98-10
 5. K60-110-10
 6. K60-123-12
 7. K76-139-12
 8. K101-164-12

I. Family Variation

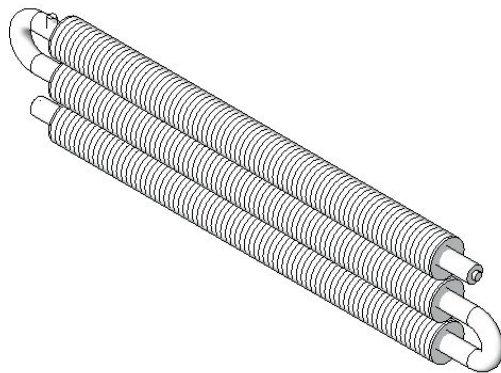
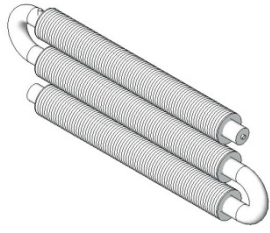
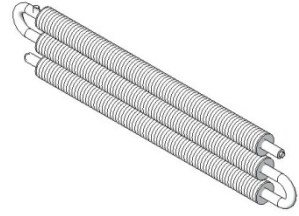

Figure 01
Family Perspectives



K33-73-08



K60-110-10

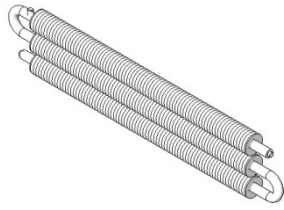

K33-83-10

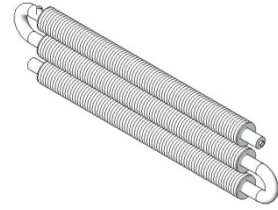

K60-123-12

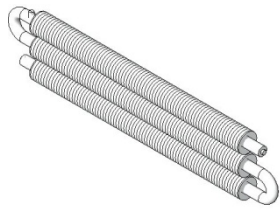

K42-92-10

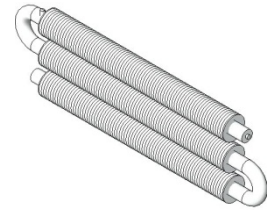

K76-139-12

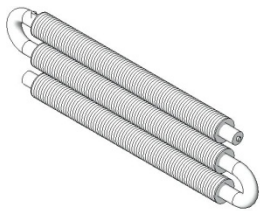

K48-98-10

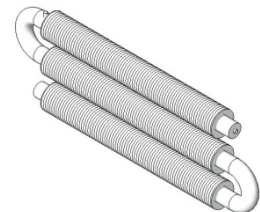

K101-164-12

Figure 02
Variation of the family elevation

II. Family Parameter and Code

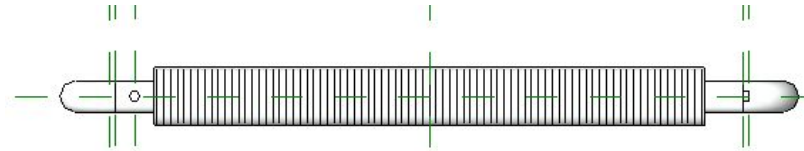

Figure 03
Family Plan Reference

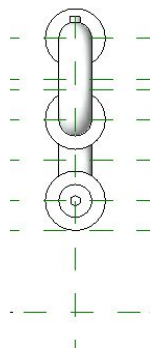

Figure 04
Family Left Reference

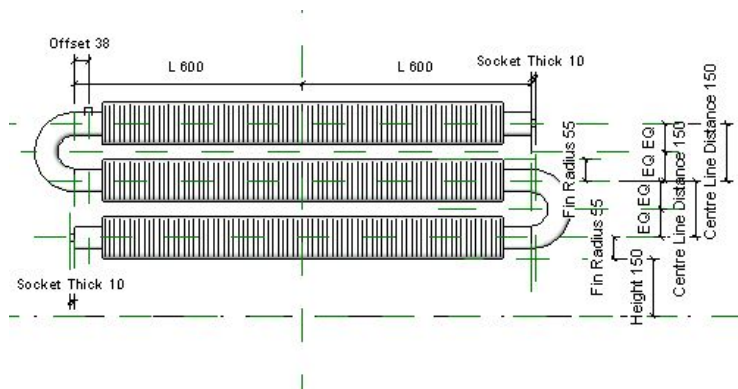

Figure 05
Family Front Reference

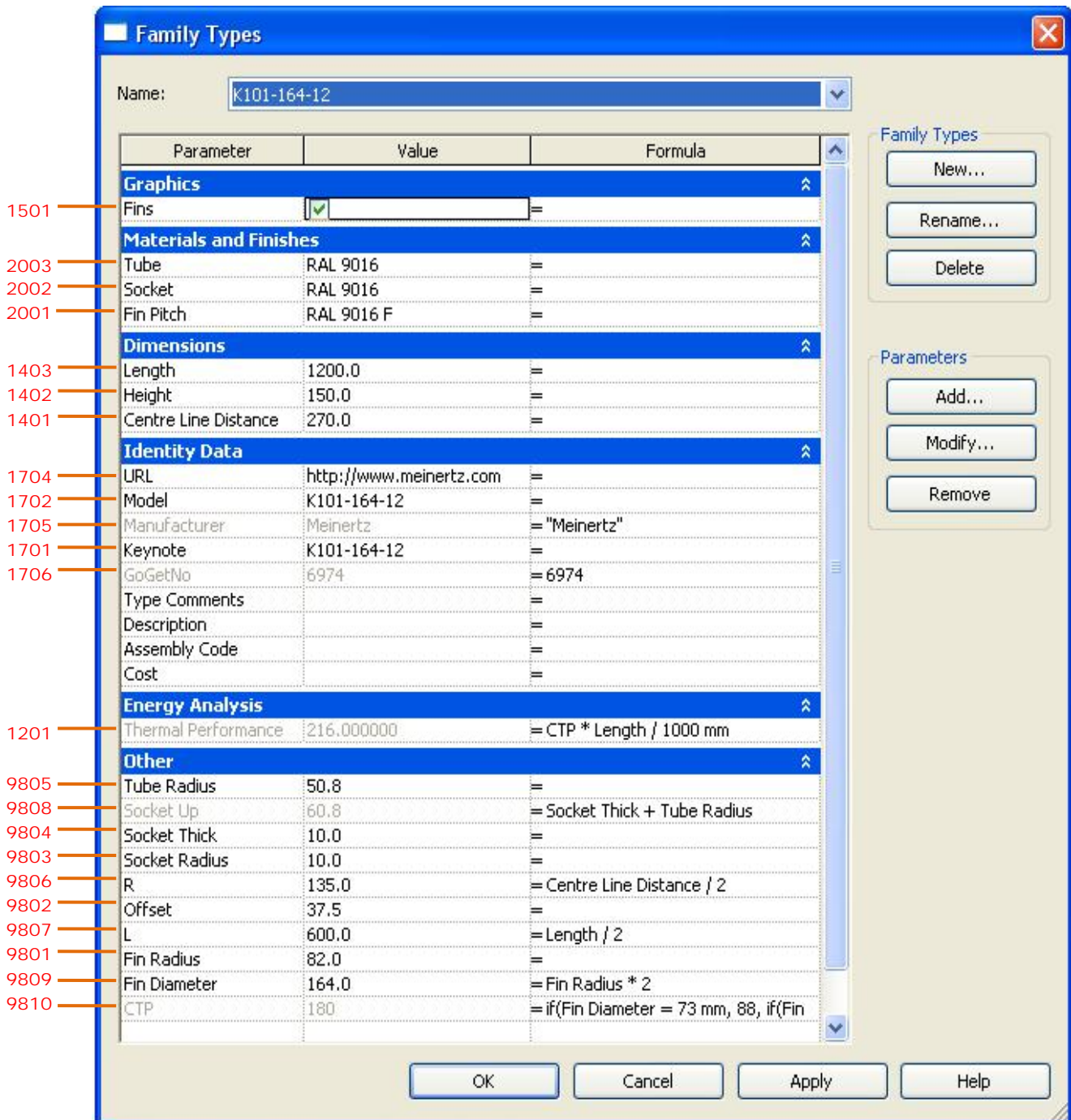
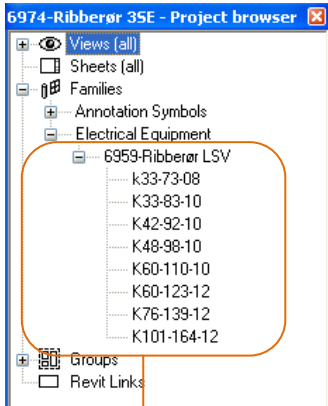

Figure 06
Family Parameter Reference

III. Sub Family



Main Family

Sub Family

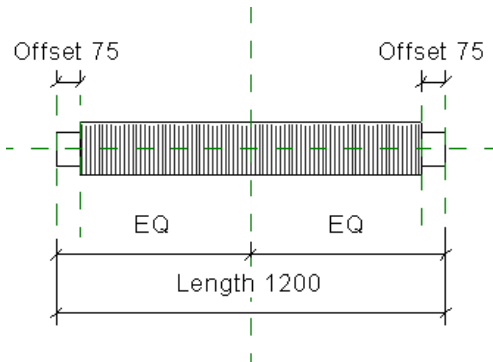

Sub family plan

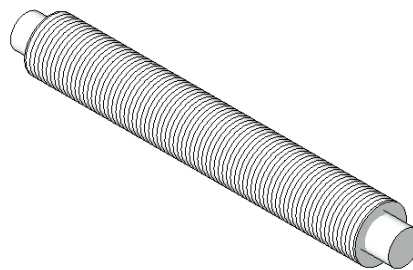

Sub family (6959-Ribberør LSV)

Sub family Parameter

Figure 07
"6959-Ribberør LSV" Sub family

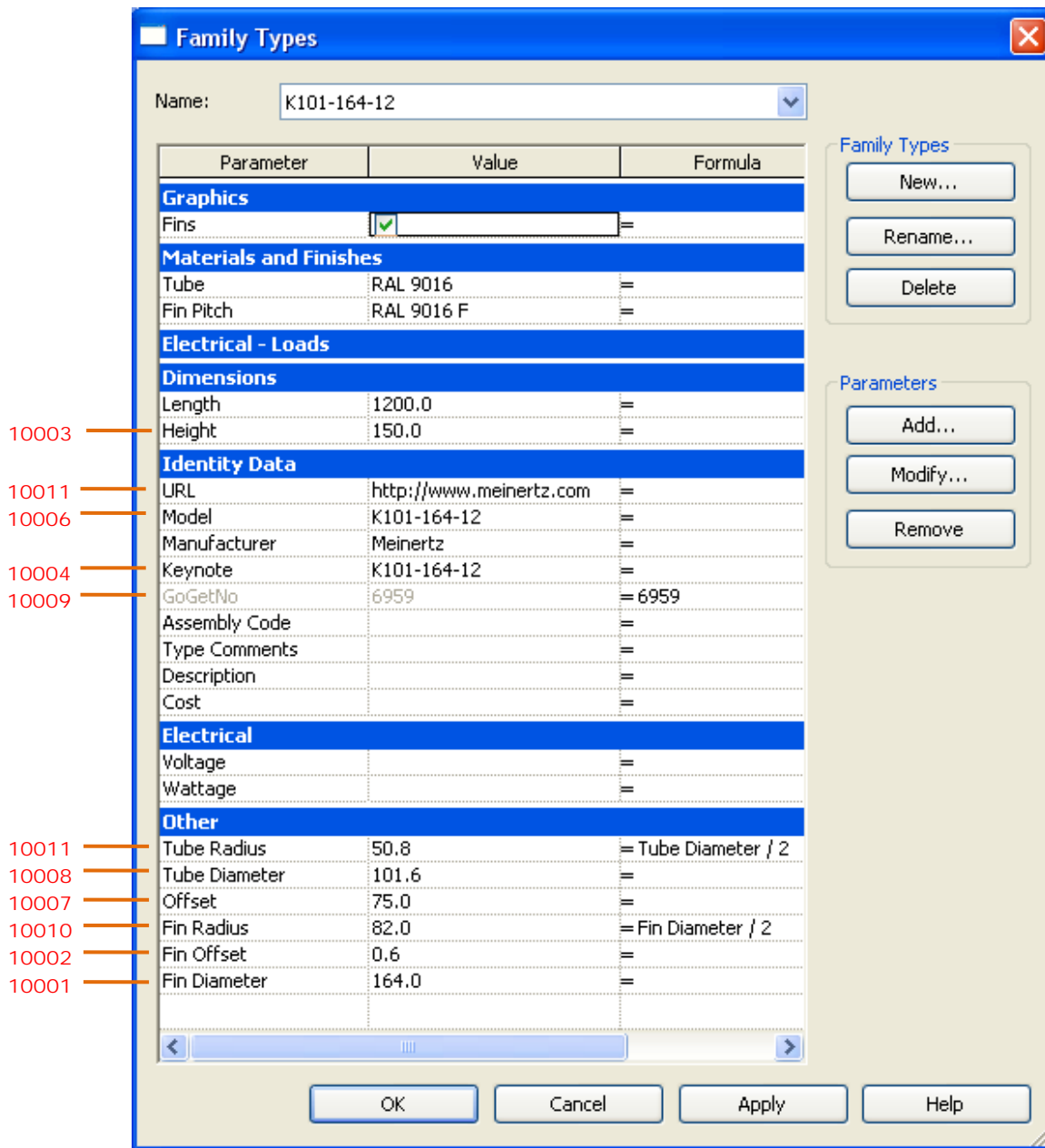

Figure 08
Sub Family Parameter Reference