Ribberør 2PE

GoGetNo: 6970

Drawing Specification of Ribberør 2PE

- ❖ Family with single view of 3d with Variation Detail
- ❖ Mechanical Equipment family
- ❖ 8 Family types :
 1. K33-73-08
 2. K33-83-10
 3. K42-92-10
 4. K48-98-10
 5. K60-110-10
 6. K60-123-12
 7. K76-139-12
 8. K101-164-12

I. Family Variation

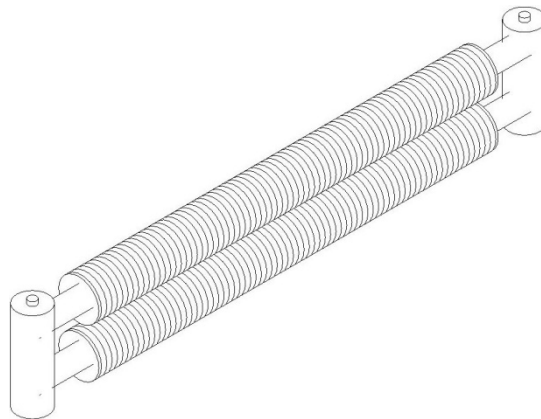
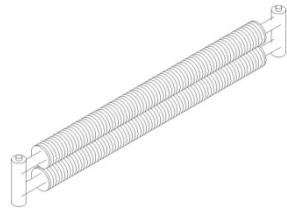
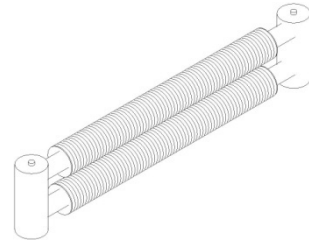

Figure 01
Family Perspectives



K33-73-08



K60-110-10

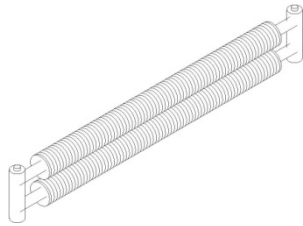

K33-83-10

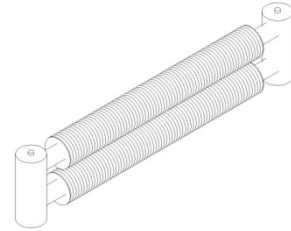

K60-123-12

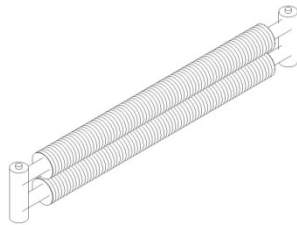

K42-92-10

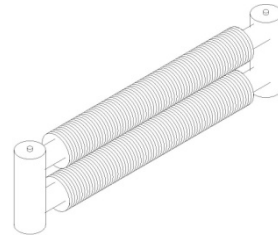

K76-139-12

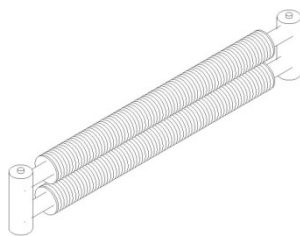

K48-98-10

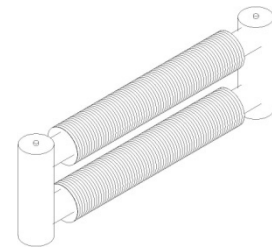

K101-164-12

Figure 02
Variation of the family elevation

II. Family Parameter and Code

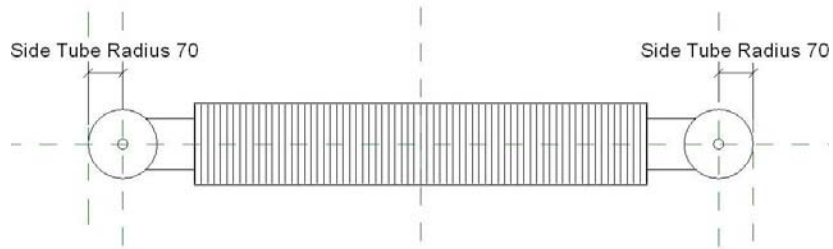

Figure 03
Family Plan Reference

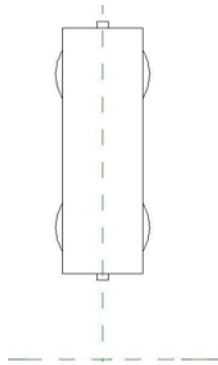

Figure 04
Family Left Reference

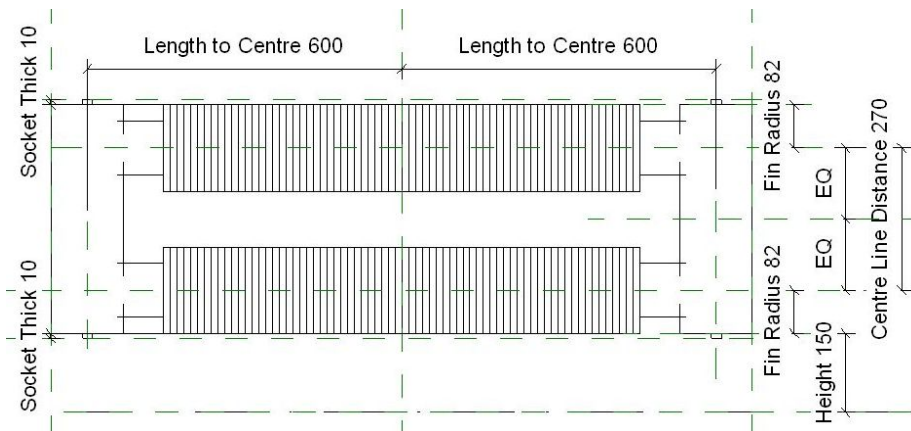

Figure 05
Family Front Reference

Family Types

Name: K60-110-10

Parameter	Value	Formula
Graphics		
1501 Fins	<input checked="" type="checkbox"/>	=
Materials and Finishes		
2003 Tube	RAL 9016	=
2002 Socket	RAL 9016	=
2001 Fin Pitch	RAL 9016 F	=
Dimensions		
1403 Length	1200.0	=
1402 Height	150.0	=
1401 Centre Line Distance	150.0	=
Identity Data		
1704 URL	http://www.meinertz.com	=
1702 Model	K60-110-10	=
1705 Manufacturer	Meinertz	= "Meinertz"
1701 Keynote	K60-110-10	=
1706 GoGetNo	6970	= 6970
Type Comments		=
Description		=
Assembly Code		=
Cost		=
Energy Analysis		
1201 Thermal Performance	216.000000	= CTP * Length / 1000 mm
Other		
9805 Tube Radius	30.2	=
9804 Socket Thick	10.0	=
9803 Socket Radius	10.0	=
9802 Side Tube Radius	54.0	=
9808 R	75.0	= Centre Line Distance / 2
9806 Offset	129.0	= 75 mm + Side Tube Radius
9807 L	600.0	= Length / 2
9801 Fin Radius	55.0	=
9809 Fin Diameter	110.0	= Fin Radius * 2
9810 CTP	180	= if(Fin Diameter = 73 mm, 88

Family Types: New..., Rename..., Delete

Parameters: Add..., Modify..., Remove

OK Cancel Apply Help

Figure 06
Family Parameter Reference

III. Sub Family

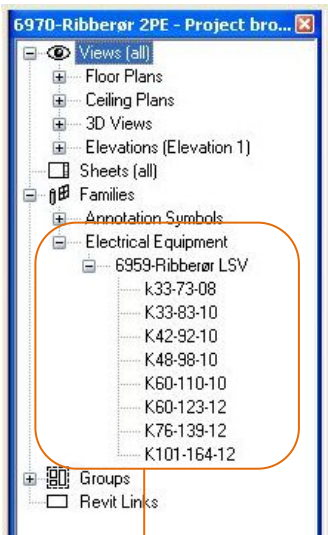

Main Family

Sub Family

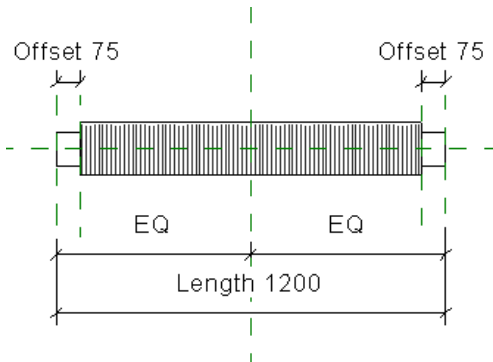

Sub family plan

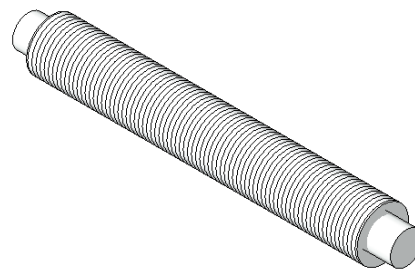

Sub family (6959-Ribberør LSV)

Figure 07
"6959-Ribberør LSV" Sub family

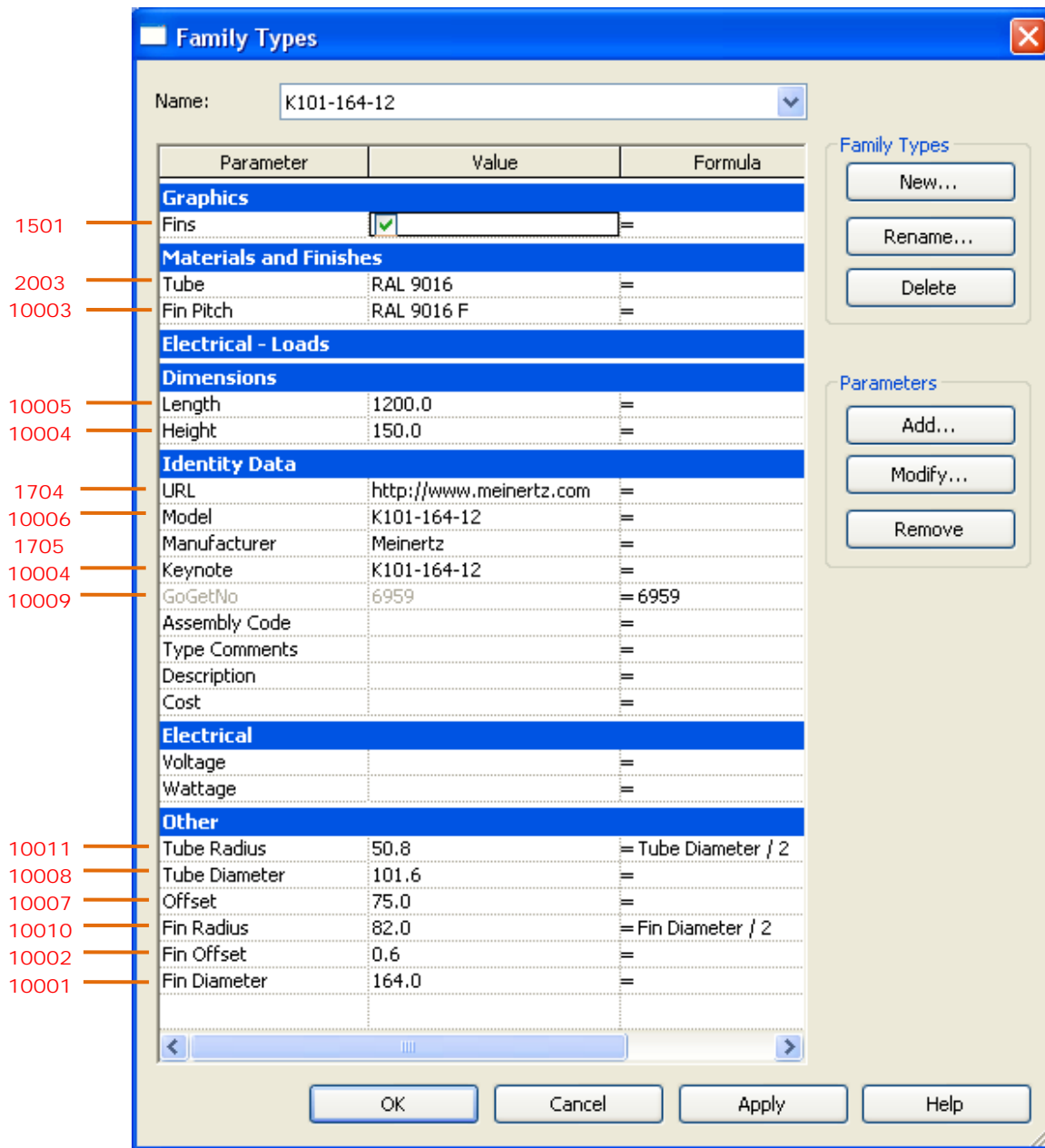

Figure 08
Sub Family Parameter Reference