

---

# Ribberør 3PE

## GoGetNo: 6973

---

Drawing Specification of Ribberør 3PE

- ❖ Family with single view of 3d with Variation Detail
- ❖ Mechanical Equipment family
- ❖ 8 Family types :
  1. K33-73-08
  2. K33-83-10
  3. K42-92-10
  4. K48-98-10
  5. K60-110-10
  6. K60-123-12
  7. K76-139-12
  8. K101-164-12

---

### I. Family Variation

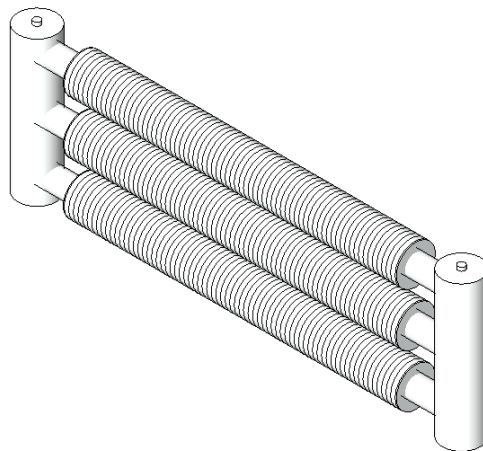

**Figure 01**  
Family Perspectives

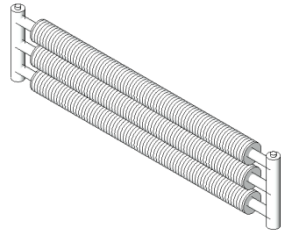

K33-73-08

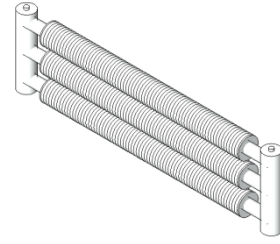

K60-110-10

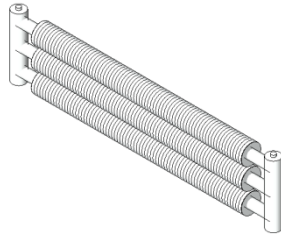

K33-83-10

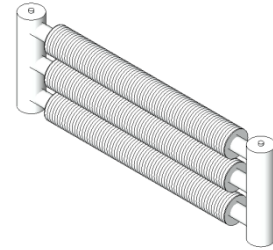

K60-123-12

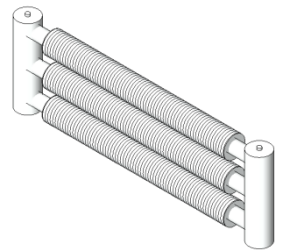

K42-92-10

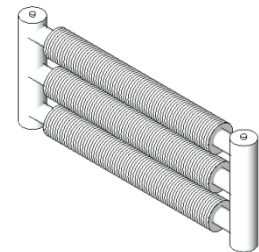

K76-139-12

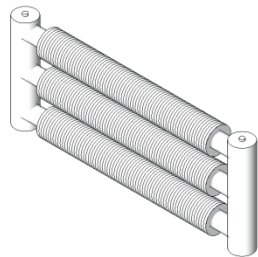

K48-98-10

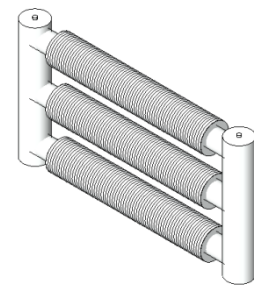

K101-164-12

**Figure 02**  
Variation of the family elevation

## II. Family Parameter and Code

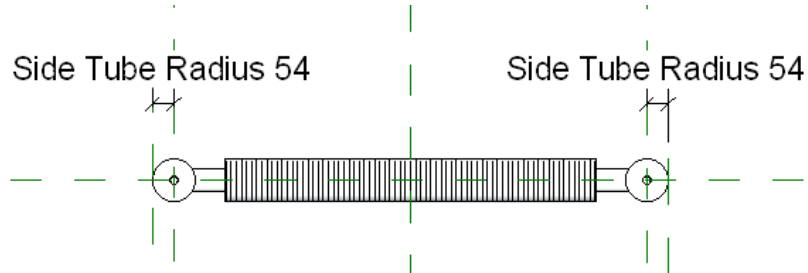

**Figure 03**  
Family Plan Reference

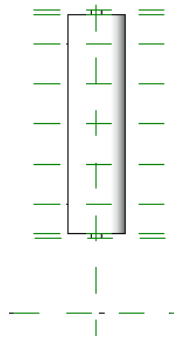

**Figure 04**  
Family Left Reference

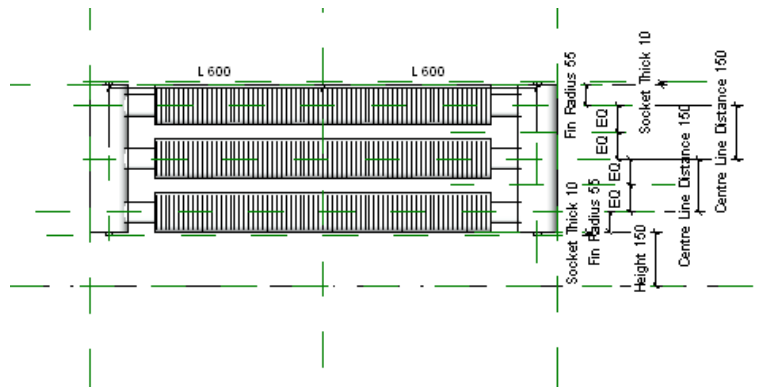

**Figure 05**  
Family Front Reference

**Family Types**

Name:

Parameter	Value	Formula
<b>Graphics</b>		
1501 Fins	<input checked="" type="checkbox"/>	=
<b>Materials and Finishes</b>		
2003 Tube	RAL 9016	=
2002 Socket	RAL 9016	=
2001 Fin Pitch	RAL 9016 F	=
<b>Dimensions</b>		
1403 Length	1200.0	=
1402 Height	150.0	=
1401 Centre Line Distance	270.0	=
<b>Identity Data</b>		
1704 URL	http://www.meinertz.com	=
1702 Model	K101-164-12	=
1705 Manufacturer	Meinertz	= "Meinertz"
1701 Keynote	K101-164-12	=
1706 GoGetNo	6973	= 6973
Type Comments		=
Description		=
Assembly Code		=
Cost		=
<b>Energy Analysis</b>		
1201 Thermal Performance	216.000000	= CTP * Length / 1000 mm
<b>Other</b>		
9805 Tube Radius	50.8	=
9804 Socket Thick	10.0	=
9803 Socket Radius	10.0	=
9802 Side Tube Radius	69.5	=
9807 R	135.0	= Centre Line Distance / 2
9806 Offset	144.5	= 75 mm + Side Tube Radius
9808 L	600.0	= Length / 2
9801 Fin Radius	82.0	=
9809 Fin Diameter	164.0	= Fin Radius * 2
9810 CTP	180	= if(Fin Diameter = 73 mm, 88, if(Fin

Family Types

New...  
Rename...  
Delete

Parameters

Add...  
Modify...  
Remove

OK Cancel Apply Help

**Figure 06**  
Family Parameter Reference

### III. Sub Family

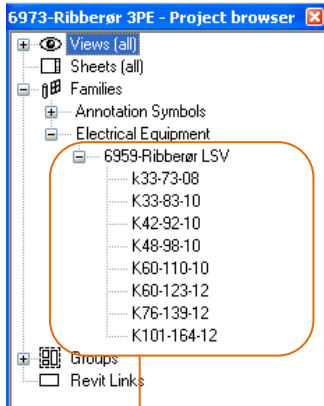

Main Family

Sub Family

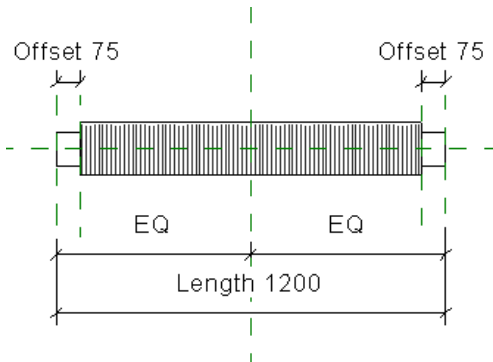

Sub family plan

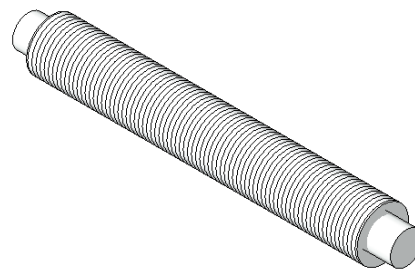

Sub family (6959-Ribberør LSV)

Figure 07  
"6959-Ribberør LSV" Sub family

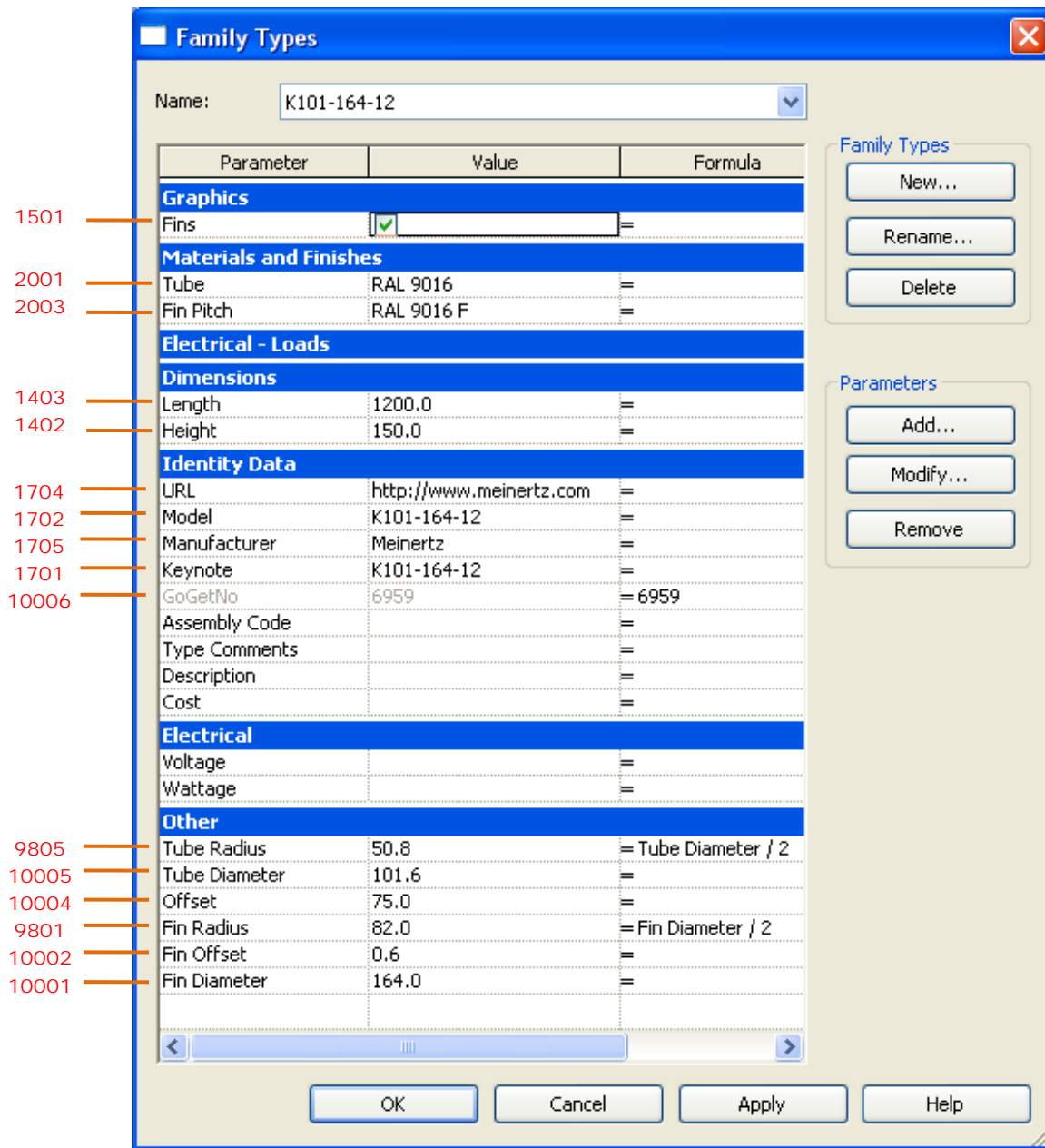

**Figure 08**  
Sub Family Parameter Reference